

# 16

## BRANDERS EN GAS OUTILS CHAUFFANTS ET GAZ

**MAGMA**  
ROOFINGSETS  
TOEBEHOREN  
VOOR GASAANSLUITING  
SOLDEERLAMPEN EN GASPATRONEN

**MAGMA**  
SETS À ROOFING  
ACCESSOIRES POUR  
RACCORDEMENT AU GAZ  
LAMPES À SOUDER ET CARTOUCHES DE GAZ

**CFH**  
ROOFINGSETS  
SOLDEREN EN BRAZEREN  
SOLDEERLAMPEN EN GASPATRONEN  
SOLDEERMATERIAAL  
ONKRUIDBRANDERS  
LASAPPARATEN  
TOEBEHOREN  
AANSTEKERS

**CFH**  
SETS À ROOFING  
SOUDER ET BRASER  
LAMPES À SOUDER ET CARTOUCHES DE GAZ  
MATÉRIEL DE SOUDURE  
DÉSHERBEURS  
POSTE À SOUDER  
ACCESSOIRES  
ALLUME-FEU

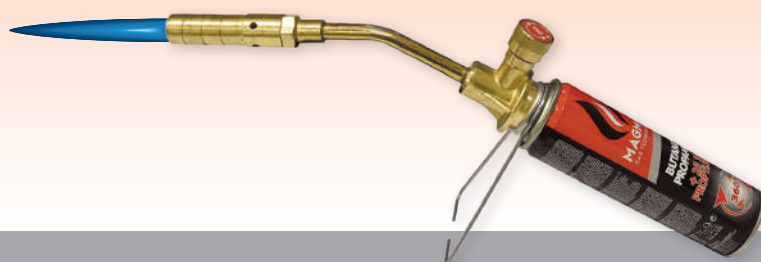
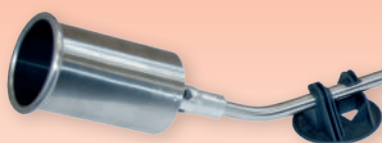

## LEGENDE • LÉGENDE



Dak- en wegwerken  
Travaux d'étanchéité



Verfabranden  
Travaux de découpage



Krimpen  
Travaux thermo-rétraction

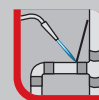

Solderen  
Travaux de soudage

**SOFT GRIP**

SOFT-GRIP handgreep  
Poignée SOFT-GRIP

**RVS INOX**

Roestvrijstaal  
Acier Inoxydable

**Ti**  
Titanium

Titanium  
Titane

**- bar +**

Regelbare druk  
Pression réglable

**= bar**

Vaste druk  
Pression fixe

**SHELL**

SHELL aansluiting  
Raccord SHELL



Draaibaar aan 360°  
Orientable à 360°



Piëzo ontsteker  
Allumage Piëzo



Regelbaar debiet  
Débit réglable

**MAX 20 bar**

Max 20 bar  
Max 20 bar



POL aansluiting  
Raccord POL

**QUICK RELEASE**

Snelkoppeling  
Raccord rapide



3/8" L aansluiting  
Raccord 3/8" G



Slang Ø 6,3 mm  
Tuyau Ø 6,3 mm



Omgeving C°  
Température



Slang Ø 8,0 mm  
Tuyau Ø 8,0 mm



Vlamtemperatuur  
Temp. de flamme



## SUPER TURBO SETS INOX

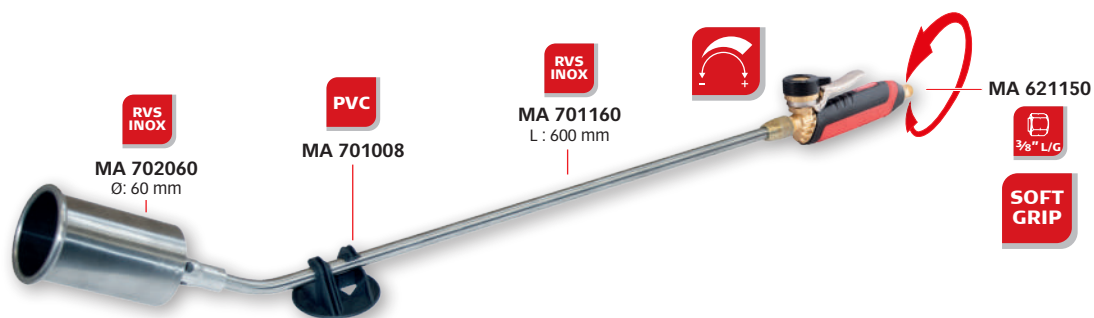

### Turbo roofingbrander INOX • Lance roofing INOX

code		L1	L2				min.	€
MA 705605	5420000059863	720	900	1,152 kg	-	1	1	108,70



Zachte vlam  
Flamme tendre

#### MA 705605

Brander Ø • Ø brûleur	60 mm
Gasverbruik, bij 4 bar Consommation de gaz à une pression de 4 bars	7,4 kg/h
Vermogen • Puissance	102 kW
Totale lengte • Longueur totale	900 mm

## SUPER TURBO SETS INOX

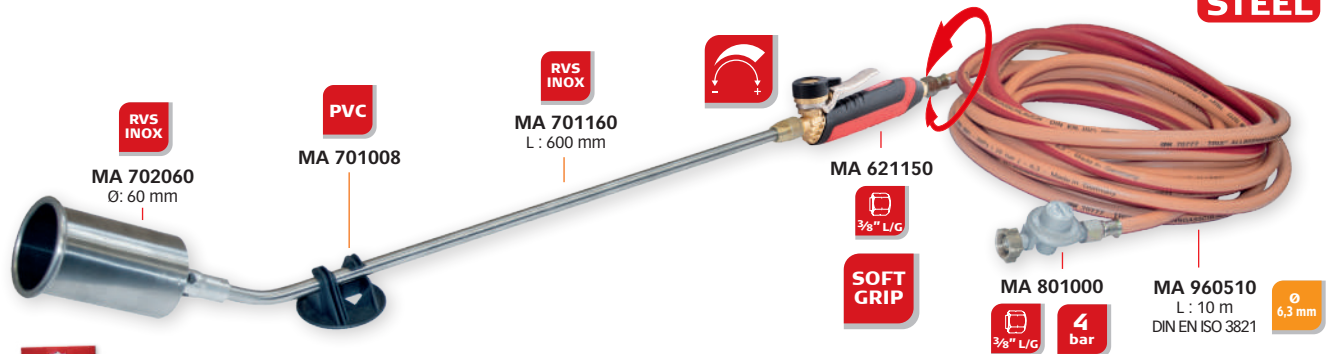

**INOX-SET met 10 m gas slang en drukregelaar 4 bar**  
**INOX-SET avec tuyau 10 m et détendeur 4 bar**

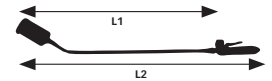

code			L1	L2				min.	€
MA 705616		5420000059870	720	900	2,716 kg	-	1	1	<b>170,50</b>



MA 705616	
Gasverbruik, bij 4 bar <i>Consommation de gaz à une pression de 4 bars</i>	7,4 kg/h
Warmte effect • <i>Effet thermique</i>	102 kW
Brander lengte • <i>Longueur du brûleur</i>	900 mm
Drukregelaar • <i>Détendeur</i>	4 bar
Gasslanglengte • <i>Longueur de tuyau</i>	10 m

## SUPER TURBO SETS TITAN

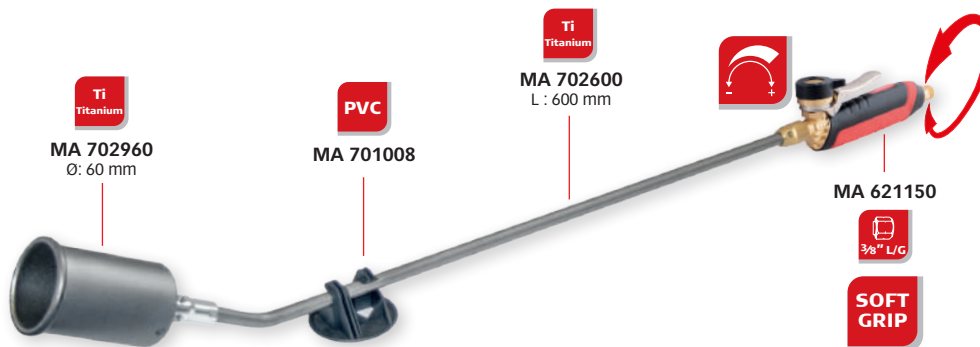

**Turbo roofingbrander TITANIUM**  
**Lance roofing TITAN**

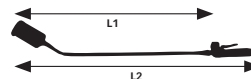

code			L1	L2				min.	€
MA 705725		5420000059887	720	900	0,662 kg	-	1	1	<b>132,10</b>



MA 705725	
Brander Ø • <i>Ø brûleur</i>	60 mm
Gasverbruik, bij 4 bar <i>Consommation de gaz à une pression de 4 bars</i>	7,4 kg/h
Vermogen • <i>Puissance</i>	102 kW
Totale lengte • <i>Longueur totale</i>	900 mm





### SUPER TURBO SETS TITAN

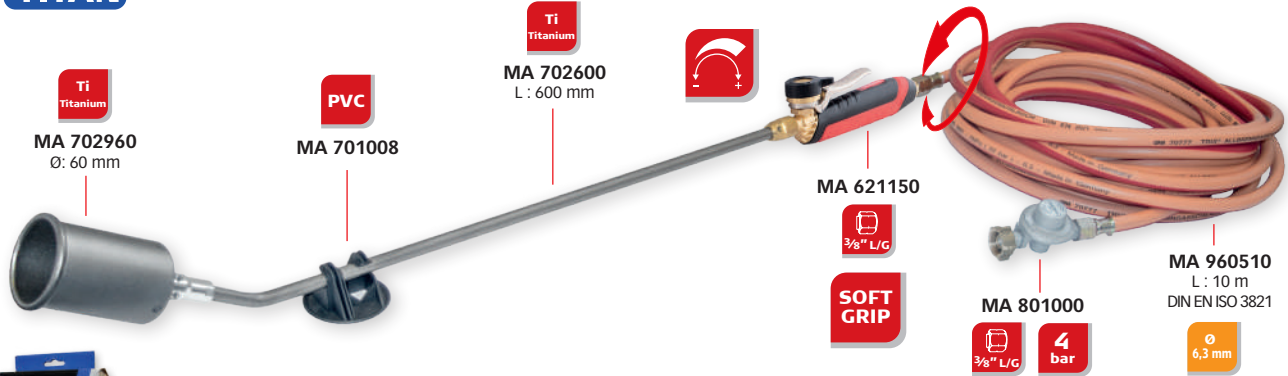

TITANIUM-SET met 10 m gaslang en drukregelaar 4 bar  
TITAN-SET avec tuyau 10 m et détendeur 4 bar

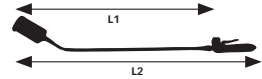

code	Barcode	L1	L2	Scales	Box	Min.	€
MA 705790	5420000059894	720	900	2,226 kg	1	1	200,00



MA 705790	
Gasverbruik, bij 4 bar Consommation de gaz à une pression de 4 bars	7,4 kg/h
Warmte effect • Effet thermique	102 kW
Brander lengte • Longueur du brûleur	900 mm
Drukregelaar • Détendeur	4 bar
Gasslanglengte • Longueur de tuyau	10 m

### Display Turbo Roofingbrander TITAN-SET (3x) + INOX-SET (6x) Display Lance Roofing Turbo TITAN-SET (3x) + INOX-SET (6x)

code	Barcode	Info	Scales	Box	Min.	€
MA AP04	-	6x INOX-SET 3x TITAN-SET	27,000 kg	-	1	1609,00



	MA 705616	MA 705790
Gasverbruik, bij 4 bar Consommation de gaz à une pression de 4 bars	7,4 kg/h	7,4 kg/h
Warmte effect • Effet thermique	102 kW	102 kW
Brander lengte • Longueur du brûleur	900 mm	900 mm
Drukregelaar • Détendeur	4 bar	4 bar
Gasslanglengte • Longueur de tuyau	10 m	10 m





## SUPER TURBO SETS TITAN

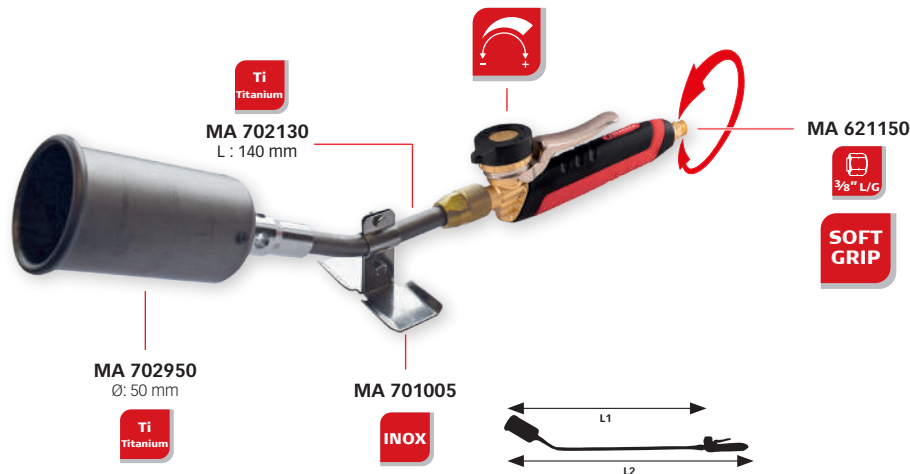

code			L1	L2				min.	€
MA 703105		5420000059849	250	400	0,604 kg	-	1	1	106,20



MA 703105	
Brander Ø • Ø brûleur	50 mm
Gasverbruik, bij 4 bar Consommation de gaz à une pression de 4 bars	4 kg/h
Warmte effect • Effet thermique	54 kW
Lengte halspijp • Longueur du tube coudé	140 mm



code			L1	L2				min.	€
MA 703160		5420000059856	250	400	1,508 kg	-	1	1	169,30



MA 703160	
Brander Ø • Ø brûleur	50 mm
Gasverbruik, bij 4 bar Consommation de gaz à une pression de 4 bars	4 kg/h
Warmte effect • Effet thermique	54 kW
Lengte halspijp • Longueur du tube coudé	140 mm
Gasslanglengte • Longueur de tuyau	10 m





Handgrip met draaisluiting en 360° koppeling  
Poignée à gachette, raccord tournant 360°

code							min.	€
MA 602000		5420000038240	SOFT-GRIP	0,330 kg	-	1	1	<b>55,20</b>



Handgrip met draaisluiting, trekker en 360° koppeling  
Poignée à gachette, raccord tournant 360°

code							min.	€
MA 621150		5420000059832	SOFT-GRIP	0,424 kg	-	1	1	<b>43,80</b>

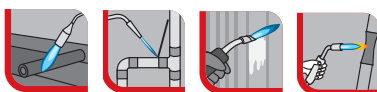

MA 602000 - MA 621150	
Hoogte • Hauteur	68 mm
Lengte • Longueur	205 mm



MA 702940  
Ø: 40 mm



MA 702950  
Ø: 50 mm



MA 702960  
Ø: 60 mm



MA 702060  
Ø: 60 mm

### Turbo branderkop • Godet turbo

code			Ø				min.	€
<b>TITANIUM • TITANIUM</b>			mm					
MA 702940		5420000045675	40	0,076 kg	-	1	1	<b>30,70</b>
MA 702950		5420000045682	50	0,098 kg	-	1	1	<b>39,62</b>
MA 702960		5420000045699	60	0,132 kg	-	1	1	<b>50,90</b>
<b>INOX • INOX</b>								
MA 702060		5420000038363	60	0,228 kg	-	1	1	<b>33,20</b>

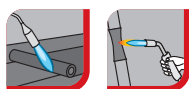

	MA 702940	MA 702950	MA 702960	MA 702060
Metaalkwaliteit • Qualité du métal	TITANIUM	TITANIUM	TITANIUM	RVS / INOX
Brander Ø • Ø brûleur	40 mm	50 mm	60 mm	60 mm
Gasverbruik bij 4 bar Consommation de gaz à une pression de 4 bar	2,7 kg/h	4 kg/h	7,4 kg/h	7,4 kg/h
Warmte effect • Effet thermique	37 kW	54 kW	102 kW	102 kW

**MA 702130**  
140 mm

**MA 702400**  
400 mm

**MA 702600**  
600 mm

**MA 701160**  
600 mm

**Lichtgewicht verlengpijpen met PVC voetstuk voor Magma branderkoppen  
Rallonges avec pied en PVC pour godets Magma**

code							min.	€
			mm					
<b>TITANIUM • TITANIUM</b>								
MA 702130		5420000045644	140	0,088 kg	-	1	1	<b>24,95</b>
MA 702400		5420000045651	400	0,132 kg	-	1	1	<b>28,45</b>
MA 702600		5420000045668	600	0,166 kg	-	1	1	<b>38,38</b>
<b>INOX • INOX</b>								
MA 701160		5420000038325	600	0,274 kg	-	1	1	<b>29,35</b>

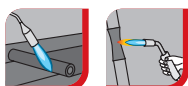

	MA 702130	MA 702400	MA 702600	MA 701160
Metaalkwaliteit • <i>Qualité du métal</i>	TITANIUM	TITANIUM	TITANIUM	RVS / INOX
Lengte • <i>Longueur</i>	140 mm	400 mm	600 mm	600 mm
Aansluiting • <i>Raccord</i>	M18	M18	M18	M18

**Voetstukken in PVC voor verlengpijpen  
Pieds en PVC pour rallonges**

code							min.	€
			mm					
MA 701008	vrac	5420000045637	Ø 70	0,024 kg	-	1	1	<b>5,72</b>





6,3 mm

MA 960505 - MA 960510



8,0 mm

MA 963920

**Rubber gasslang • Tuyaux caoutchouc**

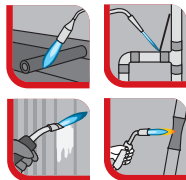
 EN 559  
DIN / ISO 3821

code							min.	€
		mm	m					
<b>Met 2 aansluitingen • Avec 2 raccords - 3/8" L</b>								
MA 960505		5420000038523	6,3	5	0,751 kg	-	1 1	<b>29,43</b>
MA 960510		5420000038530	6,3	10	1,358 kg	100	1 1	<b>60,10</b>
MA 963920	vrac	5420000038080	8,0	20	3,900 kg	-	1 1	<b>86,10</b>



MA 985063

**Koppelingen • Raccords**

code						min.	€
<b>Slangpilaar met wartel 3/8" L • Kit tétine + écrou 3/8" G</b>							
<b>Prijs per paar • Prix par paire</b>							
MA 985063		5420000038547	voor / pour Ø 6,3 mm	0,075 kg	-	1 1	<b>15,44</b>
MA 988080		5420000038554	voor / pour Ø 8 mm	0,080 kg	-	1 1	<b>17,71</b>



MA 985075 - MA 988095

**Spanbandje • Collier de serrage**

code						min.	€
<b>Prijs per 4 stuks • Prix par 4 pcs</b>							
MA 985075		5420000039018	voor / pour Ø 6,3 mm	0,010 kg	-	1 1	<b>10,87</b>
MA 988095		5420000039025	voor / pour Ø 8,0 mm	0,015 kg	-	1 1	<b>10,87</b>



**DRUKREGELAAR MET VASTE DRUK**  
**DÉTENDEUR À PRESSION FIXE**

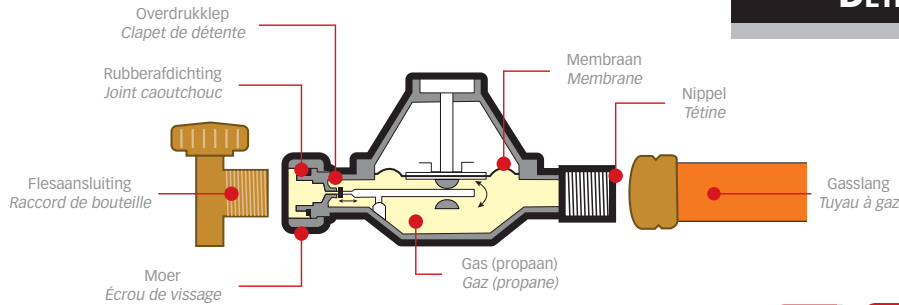

code							min.	€
MA 802000		5420000038431	2 bar	0,074 kg	-	1	1	25,29
MA 801000		5420000038424	4 bar	0,076 kg	-	1	1	26,75

**DRUKREGELAAR MET INSTELBARE DRUK**  
**DÉTENDEUR À PRESSION VARIABLE**

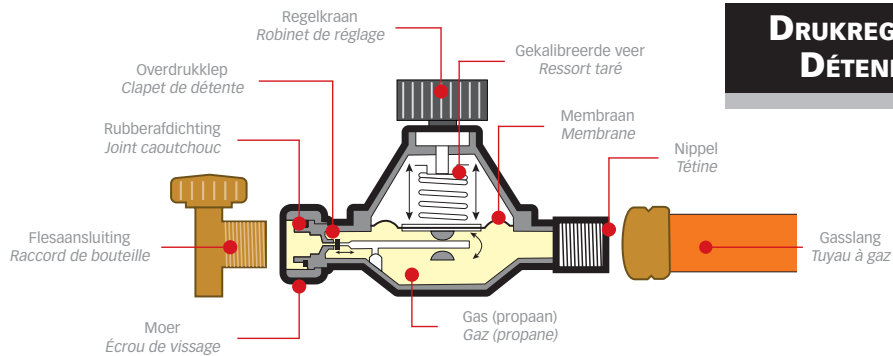

MA 803040

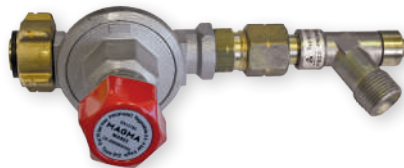

MA 803685

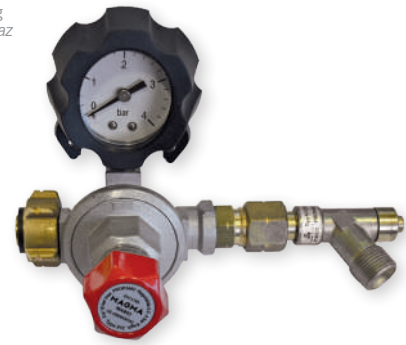







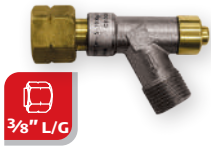

MA 803690

code							min.	€
MA 803040		5420000038448	0,5-4 bar	0,220 kg	-	1	1	29,91
<b>Met slangbreukventiel • Avec valve de rupture</b>								
MA 803685		5420000038455	0,5-4 bar	0,304 kg	-	1	1	45,72
<b>Met slangbreukventiel en manometer • Avec valve de rupture et manomètre</b>								
MA 803690		5420000038882	0,5-4 bar	0,406 kg	-	1	1	57,30









	MA 802000	MA 801000	MA 803040	MA 803685	MA 803690
Aansluiting • Raccord	3/8" L/G	3/8" L/G	3/8" L/G	3/8" L/G	3/8" L/G
Gastype • Type de gaz	Propa(a)n(e)	Propa(a)n(e)	Propa(a)n(e)	Propa(a)n(e)	Propa(a)n(e)
Druk • Pression	2 bar	4 bar	0,5 - 4 bar	0,5 - 4 bar	0,5 - 4 bar
Slangbreukventiel • Valve de rupture	-	-	-	✓	✓
Manometer • Manomètre	-	-	-	-	✓
Maximale afgifte • Capacité maximale	8 kg / h	8 kg / h	8 kg / h	8 kg / h	10 - 14 kg / h

**Slangbreukventiel met resetknop  
Valve de rupture avec bouton de remise à zero**

code				bar	kg/h				min.	€
MA 803728		5420000058897	uitgang / sortie 3/8" M	0,5-4	5-10	0,083 kg	-	1	1	<b>17,45</b>

**Slangbreukventiel met resetknop  
Valve de rupture avec bouton de remise à zero**

code				bar	kg/h				min.	€
MA 803710		5420000038899	uitgang / sortie 3/8" M	1,5-4	10-14	0,084 kg	-	1	1	<b>17,85</b>

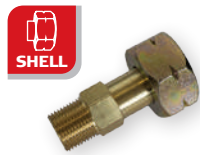
**Veiligheidsklep met SHELL aansluiting • Valve de sécurité avec sortie SHELL**



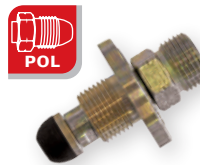





code							min.	€	
Voor fles 11-13 kg • Pour bouteille 11-13 kg									
MA 804050		5420000038936	uitgang / sortie 3/8" M	0,226 kg	-	1	1	<b>17,58</b>	

**Adapter met POL aansluiting • Adaptateur avec sortie POL**







code							min.	€	
Voor fles 47 kg • Pour bouteille 47 kg									
MA 804015		5420000038929	-	0,122 kg	-	1	1	<b>11,55</b>	

	MA 803728	MA 803710	MA 804050	MA 804015
Aansluiting • Raccord	3/8" L/G	3/8" L/G	SHELL	POL
Maximale afgifte • Capacité maximale	5 - 10 kg/h	10 - 14 kg/h	10 - 14 kg / h	-

**Hervulbare propaanfles zonder gasinhoud (leeg)  
Bouteille propane remplissable sans gaz (vide)**

code							min.	€	
MA 779602	vrac	5420000037328	2 kg propaan / propane	3,540 kg	96	4	1	<b>84,20</b>	
Vulpijp in messing SHELL • Raccord de transvasement SHELL									
MA 779500		5420000038967	140 mm - SHELL	0,176 kg	-	1	1	<b>21,97</b>	

**Hulpstaander om propaanflessen veilig te vullen  
Trépied pour remplissage sécurisé de bouteille à propane**

code							min.	€
MA 779747	vrac	5420000038974	(H) 60 x (Ø) 35 cm	3,500 kg	-	1	1	<b>133,10</b>

Fles niet inbegrepen • Bouteille non-incluse



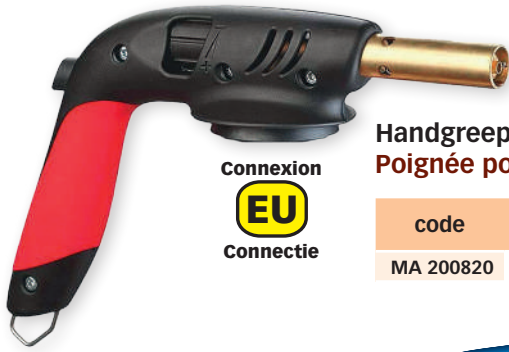

Connexion  
**EU**  
Connectie

Handgrip voor professionele brander  
Poignée pour lampe à souder professionnel



code			i			min.	€
MA 200820			360°			1	<b>30,82</b>

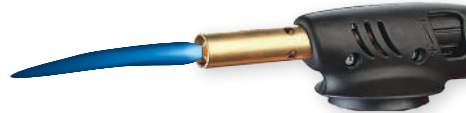

MA 200820	
Vermogen • Puissance	1370 W
Maximale afgifte • Capacité maximale	105 gr / h



Connexion  
**EU**  
Connectie

Gaspatroon "NOVACET PLUS" Kemper  
Cartouche de gaz "NOVACET PLUS" Kemper

**KEMPER**  
EN 417

code			i	T°			min.	€
KF 580S	vrac		ml	2200°C			1	<b>7,10</b>



Veiligheidsventiel en uitwendige schroefdraad EU aansluiting, besturingssysteem in alle posities. Voor gebruik bij hoge temperaturen.

Valve de sécurité et filetage externe connexion EU, système de fonctionnement en toute position. Pour utilisation en haute température.



Connexion  
**EU**  
Connectie

EN 417

Turbo soldeerbranderkop 360° met gaspatroon "TURBOGAS" + voetje  
Lance à braser turbo 360° avec cartouche de gaz "TURBOGAZ" + pied

code			i			min.	€
MA 810130	vrac		360°			1	<b>29,46</b>



Gaspatroon "TURBO GAS"  
Cartouche de gaz "TURBO GAZ"



code			i			min.	€
MA 446000	vrac		60 gr			12	<b>4,93</b>



	MA 446000	KF 580S
Gastype • Type de gaz	Buta(a)n(e) / Propa(a)n(e) 25% Propyle(e)n(e)	Buta(a)n(e) / Propa(a)n(e) Propyle(e)n(e)
Temperatuur • Température	tot / jusque 2100°C	tot / jusque 2200°C
Aansluiting • Raccord	EU	EU
Inhoud • Contenu	110 ml	380 ml



Soldeerlamp • Lampe à souder



code							min.	€
MA 200250		542000044890	360° (na/après 30 sec)	0,550 kg	270	6	1	31,52

Gaspatroon niet inbegrepen • Cartouche non-incluse

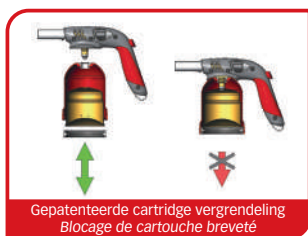

	MA 200250
Gastype • Type de gaz	Buta(a)n(e)
Vermogen • Puissance	1,54 kW
Autonomie • Autonomie	Min. 1 u/h 50 - Max. 5 u/h 50
Debiet • Débit	118 g / h
Gaspatroon • Cartouche	CFH 52149 / KF 1120S

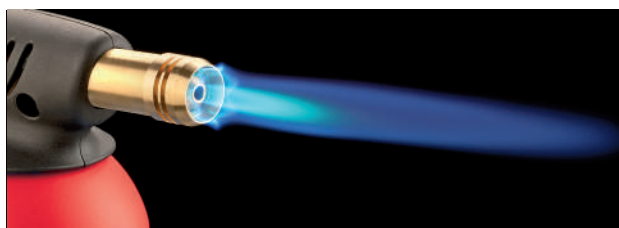

### Gaspatroon "STOP GAS" Butaan Cartouche de gaz "STOP GAZ" Butane



EN 417



code				T°				min.	€
KF 1120S	vrac	8004220015877	gr	1200°C	0,300 kg	1296	36	36	2,33

"STOP GAS" SYSTEM

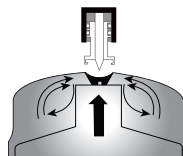
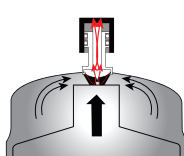

NORMAL

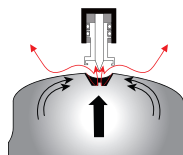
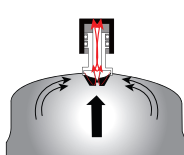

Intern veiligheidssysteem dat de doorgang van het gas blokkeert bij het losschroeven  
Système de sûreté interne qui bloque le passage du gaz en cas de dévissage

**Elektrische soldeerbout - 230 Volt**  
**Fer à souder électrique - 230 Volt**



code							min.	€
							bout/panne	
KF 3035N		8008004012250		210 gr	180 W	0,712 kg	- 6 1	<b>48,40</b>
KF 3040N		8008004012304		310 gr	250 W	0,861 kg	- 6 1	<b>55,60</b>

**Professionele brander met 1 kop**  
**Lampe à souder professionnel avec 1 tête**



code						min.	€
KF 1065		8008004133221	EU	0,620 kg	- 6 1	<b>112,90</b>	



TURBO	
Vermogen / Puissance	3670 W
Maximale afgifte • Capacité maximale	110 gr / h



**Patronen "KEMAP" gas**  
**Cartouches "KEMAP" gas**



EN 12205 / EN 417 / ISO 11118

code			T°				min.	€
KF 581		8008004107901	410 ml / 250 gr	2400°C	0,550 kg	- 6 6	<b>18,20</b>	

KEMAP is een speciaal mengsel van brandbare gassen en schuim, die door toepassing van acetyleen een hoge productiviteit garandeert in lasactiviteiten. 360° draaibaar.

**Specificaties:**

- Combineert hoge vlamtemperatuur en een hoge verbrandingswaarde met complete stabiliteit en de afwezigheid van toxische componenten, met bijna geen ontwikkeling van een terugkerende vlam.

KEMAP est un mélange spécial de gaz combustibles et de mousse qui garantit une productivité élevée normalement obtenue par l'utilisation d'acétylène dans les activités de soudure. 360° orientable.

**Spécifications:**

- Combine une température élevée de la flamme et un grand pouvoir calorifique avec la stabilité complète ainsi que l'absence de composants toxiques et la quasi absence de tendance de retour de flamme.

**Adapters : connecties voor "KEMAP" gas**  
**Adaptateurs : connections pour gaz "KEMAP"**

code						min.	€
KF 583		8008004113506	USA→EU	0,061 kg	- 1 1	<b>14,21</b>	
KF 584		8008004113513	EU→USA	0,114 kg	- 1 1	<b>14,21</b>	

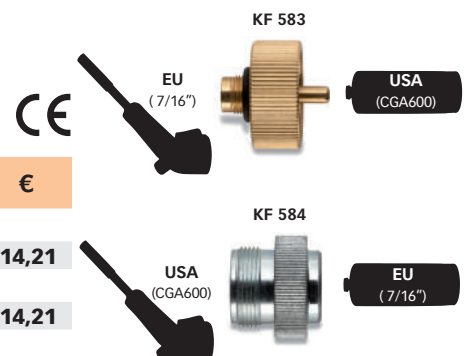

## LEGENDE • LÉGENDE



Solderen mogelijk in alle posities  
Soudure possible dans toutes les positions



Draaibare veiligheidsaansluiting  
Branchement de sécurité pivotante



Piezo  
Piézo-ontsteking  
Allumage Piézo



Werktemperatuur  
Température de la panne



Soldeerpunttemperatuur  
Température de soudure



## ST 500

new  
design



code			Ø					min.	€
CFH 52074		4001845520742	mm	mm	0,900 kg	-	2	1	38,24

## ST 1000

new  
design

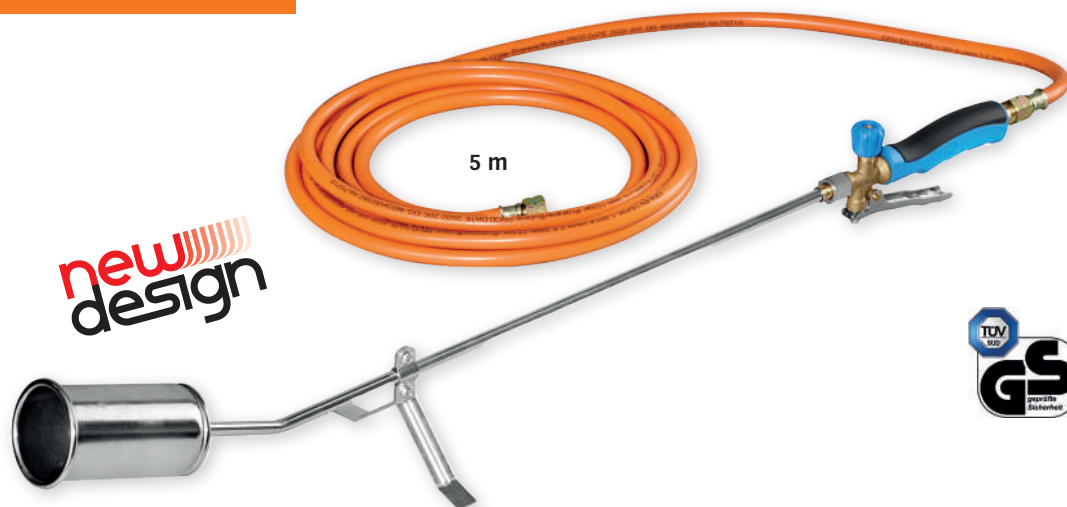

code			Ø					min.	€
CFH 52082		4001845520827	mm	mm	1,588 kg	64	16	1	47,13

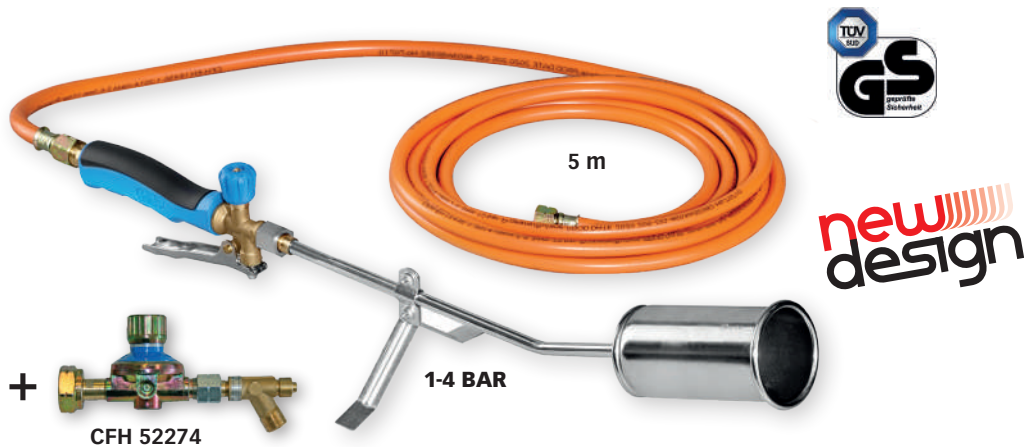
**SV 800**

**new design**

code			Ø					min.	€
CFH 52080		4001845520803	mm 60	mm 470	1,817 kg	-	4	1	<b>69,10</b>

Bijzonder handig, krachtig opwarm- en afbrandtoestel met korte buis en speciale brander. Ideaal voor moeilijk toegankelijke plaatsen. Inclusief spaarvlamgreep om energie te besparen, houder en gas slang voor gangbare propaanflessen van 5, 11 en 33 kg.

**Toepassingsmogelijkheden:**

Onkruidverdelger en verwijderen van mos (ook op muren), werken met bitumen, dakisolatie, lassen van vijfverfolie. Uitermate geschikt voor het aansteken van houtskoolbarbecues en het afbranden van varkenshaar.

**DRUKREGELAAR 2,5 BAR ABSOLUUT NOODZAKELIJK**  
Zie blz.376

Appareil de réchauffage et de flambage très performant avec chalumeau simple sans bord rabattu, tuyau et poignée fermement fixés. Complet avec poignée en veilleuse pour des économies d'énergie, colonne de support et tuyau à gaz pour bouteilles de gaz propane du commerce de 5, 11 et 33 kg.

**Possibilités d'application:**

pour la destruction de mauvaises herbes et la mousse également sur les murs, pour travailler le bitume, isoler les toits, souder des bâches pour bassins. Excellent pour allumer le barbecue à charbon de bois et pour brûler les soies de porc.

**UTILISATION D'UN RÉGULATEUR DE PRESSION 2,5 BAR  
ABSOLUMENT NÉCESSAIRE**

Voir p.376

**PZ 6000**

**new design**
**P Piezo**

code			Ø					min.	€
CFH 52078		4001845520780	mm 60	mm 900	1,845 kg	-	4	1	<b>63,80</b>



+



CFH 52105



**P** Piezo

- Handige en krachtige soldeerbout
- Toepassingsgebieden: zachtsolderen van dakgoten, koperen platen en gegalvaniseerde staalplaten tot 1 mm dik
- Zeer eenvoudige ontsteking door de Piëzo-ontstekingsknop
- De soldeerbout kan worden gebruikt met een 60 g gaspatroon
- Ondersteuning inbegrepen
- 1 x gaspatroon inbegrepen

	CFH 51932
Gasverbruik bij 2 bar <i>Consommation de gaz à une pression de 2 bars</i>	56,4 g/h
Warmte-effect • <i>Effet thermique</i>	0,78 kW
Bout • <i>Panne</i>	235 gr
Grootte van de bout • <i>Taille de la panne</i>	35 x 3,5 mm
Gewicht • <i>Poids</i>	1,028 kg

- Fer à souder pratique et puissant
- Application: brasage tendre sur gouttières, tôles de cuivre et tôles d'acier galvanisées d'une épaisseur pouvant atteindre 1 mm
- Allumage pratique par simple pression sur le bouton d'allumage Piëzo
- Le fer à souder peut être utilisé avec une cartouche de gaz de 60 g
- Support inclus
- 1 x cartouche de gaz incluse

#### Autonome soldeerbout • Fer à souder autonome

code							min.	€
CFH 51932		4001845519326	235 gr	35 x 3,5 mm	1,130 kg	-	2 1	176,70
Vervangcartouche "TURBO GAS" • <i>Cartouche de remplacement "TURBO GAZ"</i>								
MA 446000	vrac	5420000038011	60 gr	-	0,112 kg	2880	12 12	4,93



MA 446000

Vervangcartouches op blz 380  
Cartouches de remplacement sur la p. 380

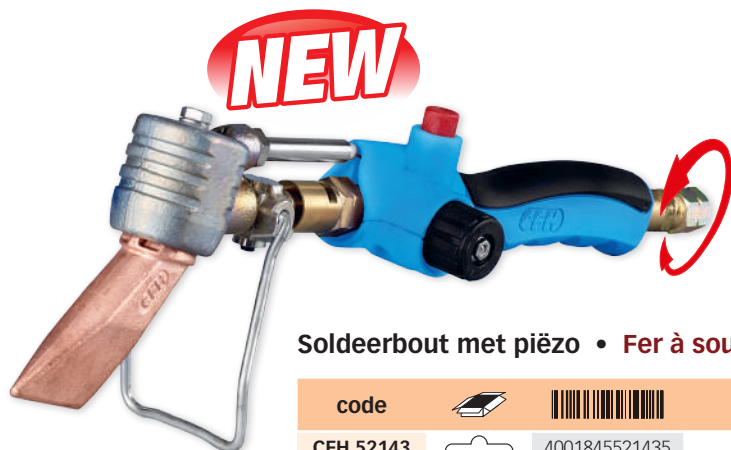

**P** Piezo

#### Soldeerbout met piëzo • Fer à souder avec piëzo

code							min.	€
CFH 52143		4001845521435	235 gr	35 x 3,5 mm	0,790	-	6 1	125,00





**Soldeerbouten • Panne**

code								min.	€
<b>Soldeerbouten in koper • Panne en cuivre</b>									
CFH 51940		4001845519401	KS 940 - 235 gr	35 x 3,5 mm	0,260 kg	-	1	1	<b>37,04</b>
CFH 51944		4001845519449	KS 944 - 315 gr	45 x 5 mm	0,335 kg	-	1	1	<b>38,36</b>
<b>Soldeerbouten Long Life • Panne en cuivre Long Life</b>									
CFH 51946		4001845519463	KSL 946 - 235 gr	35 x 3,5 mm	0,260 kg	-	1	1	<b>102,90</b>
CFH 51950		4001845519500	KSL 950 - 315 gr	45 x 5 mm	0,315 kg	-	1	1	<b>103,80</b>



Deze krachtige hamer-soldeerbout is uitgerust met een hoogwaardige koperen bout van 350 g. Deze bout kan door het losdraaien van een schroef eenvoudig verwijderd worden, zodat het toestel ook als normale soldeerblander gebruikt kan worden.

**Toepassingsmogelijkheden:** zachtsolderen van dakgoten, koperplaten en verzinkt plaatstaal tot 1 mm metaaldikte

Ce fer à braser à marteau est équipé d'une masse de cuivre de 350 g qui s'enlève facilement en dévissant une vis. L'appareil peut ainsi être utilisé comme fer à braser normal.

**Possibilités d'applications:** Brasage tendre sur gouttières, tôle de cuivre et tôle d'acier zinguée jusqu'à 1 mm d'épaisseur.

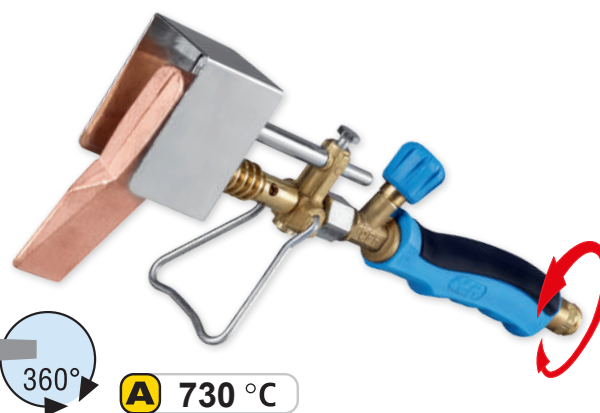

**Hamer soldeerbout • Fers à braser à marteau**

code							min.	€	
CFH 52147		4001845521473	KL 147	0,950 kg	-	6	1	<b>52,90</b>	
<b>Koper bouten • Panne en cuivre</b>									
CFH 52770		4001845527703	Bijlform / Forme hache	0,400 kg	-	1	1	<b>23,57</b>	



## TOEBEHOREN • ACCESSOIRES

## Rubber gaslang • Tuyaux caoutchouc

code								min.	€	
		mm	m							
Met 2 aansluitingen • Avec 2 raccords - 3/8" L										
CFH 52758		4001845527581	6,3	2	DIN EN ISO 3821	0,150 kg	-	1	1	<b>16,78</b>
CFH 52780		4001845527802	6,3	10	DIN EN ISO 3821	1,500 kg	-	1	1	<b>60,10</b>

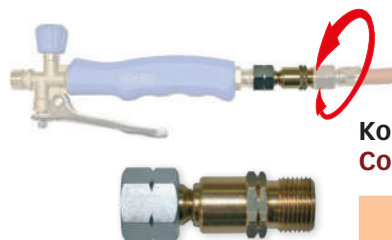
Koppelstuk met draadverbinding  
Connecteur avec connexion filaire

code						min.	€	
CFH 52120		4001845521206	-	0,076 kg	-	1	1	<b>14,72</b>

## Drukregelaars • Détendeurs

code						min.	€	
Vaste druk • Pression fixe								
CFH 52268		4001845522685	2,5 bar	0,274 kg	-	1	1	<b>20,95</b>
Instelbare druk • Pression variable								
CFH 52274		4001845522746	1 - 4 bar	0,443 kg	-	20	1	<b>39,63</b>

CE



## Slangbreukventiel • Valve de rupture

code						min.	€	
CFH 52118		4001845521183	1,5 - 4 bar	0,110 kg	-	1	1	<b>18,00</b>

CE

## Spanbandjes met vijs • Colliers serflex

code						min.	€	
CFH 952		5420000039261	Ø 10-16 mm	0,010 kg	-	50	1	<b>1,13</b>
CFH 932		5420000039254	Ø 20-32 mm	0,015 kg	-	50	1	<b>1,11</b>

NEW

## Transportwagen voor gasflessen • Chariot pour bonbonnes de gaz

code						min.	€	
CFH 52089		4001845520896	-	4,300 kg	84	3	1	<b>67,70</b>



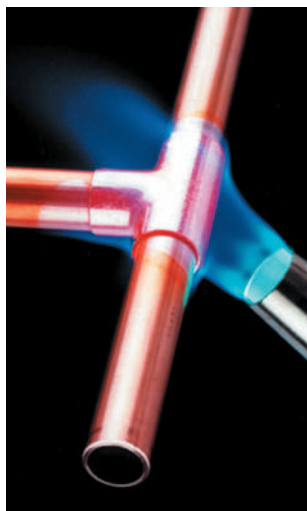

**GT 2000**

Krchtig en praktisch handsoldeertoestel.  
Voor hard- en zachtsolderen van koperen  
en stalen buizen.  
Met hoogwaardige turbosoldeerbrander.

Performant et pratique.  
Pour le brasage à haute température et  
tendre de tuyaux en cuivre et acier  
Chalumeau turbo haute qualité.



**Handsoldeerder met 1,5 meter gaslang  
Appareil de brasage avec 1,5 mètre de tuyau à gaz**

**A 800 °C**

code		Ø				min.	€
CFH 52060		24	0,760 kg	-	1	1	<b>42,35</b>

**PRO TURBO**

**Profi soldeerset met 1,5 meter gaslang  
Profi Set à souder avec 1,5 mètre de tuyau à gaz**

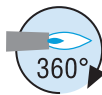

**PUNT  
POINTE A 600 °C**

**TURBO A 800 °C**

**NEW**

code		Ø				min.	€
CFH 52090		20 (Turbo) - 14 (Point)	1,390 kg	-	1	1	<b>67,00</b>



**TURBO 2000**

**Soldeerkoffer • Coffret de brasseur**

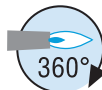

**A 800 °C**

code						min.	€
CFH 52055		16 st / pcs	2,937 kg	-	1	1	<b>122,10</b>

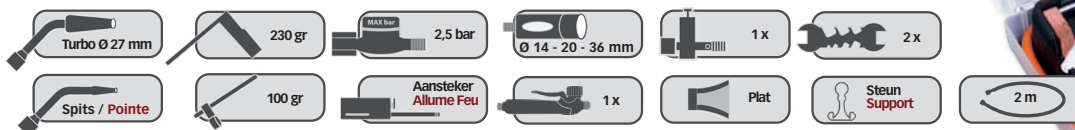

**Toepassingsmogelijkheden:** zacht- en hardsolderen, smelten, afbranden, opwarmen, afschroeiën, ontdooien en harden.

**Applications possibles:** pour le brasage à haute température et tendre, la fusion, le flambage, le réchauffage, le décapage, le dégelage et la trempe.



**LAS-FIX SF 3100**

**LAS-FIX • Dispositif de soudeur**

**A 1250 °C**

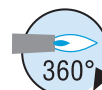

code						min.	€
CFH 52500		SF 3100	4,140 kg	-	2	1	<b>138,20</b>
<b>Reservezuurstoffles • Bouteille d'oxygène</b>							
CFH 52505		1 L	1,320 kg	-	6	1	<b>29,48</b>
<b>AT 3000 : butaan + propaan + propyleen • butane + propane + propylène</b>							
CFH 52515		330 gr	0,460 kg	-	6	1	<b>8,77</b>





CFH 52170



**A** 650 °C

### LM 3000

- Mobiel, krachtig soldeertoestel met patroon en slang. Voor zacht- en hardsolderen, opwarmen, ontdooien, afbranden, vertinnen, afschroeiën, smelten, voor de behandeling van thermoplast en het aansteken van barbecues.
- Appareil de brasage mobile et performant avec tuyau. Pour le brasage tendre et à haute température, le réchauffage, le dégelage, le flambage, l'étamage, la fusion, le traitement thermique des matières plastiques et l'allumage du charbon de bois.



CFH 52156



**A** 650 °C

CFH 52159

### LM 1000

- Voor zachtsolderen en éénvoudig hardsoldeerwerk. Voor reparatie- en installatiewerkzaamheden, doe-het-zelf, afbranden van hout, vertinnen en bewerken van kunststof.
- Pour le brasage tendre et simple travaux de brassage à haute température. Pour travaux de réparation, d'installation et de bricolage, ainsi que pour le décapage de la peinture et le désherbage, le décapage du bois, l'étamage et le traitement des matières plastiques.



CFH 52192



### PZO 7000

- Zeer krachtige brander, stevige, ergonomisch gevormde handgreep. Voor reparatie- en installatiewerkzaamheden, doe-het-zelf, afbranden van hout, vertinnen en bewerken van kunststof. Vlamondersteunde brander met windbescherming.
- Avec chalumeau à haute performance, poignée stable, forme ergonomique. Pour travaux de réparation, d'installation et de bricolage, ainsi que pour le décapage de la peinture et le désherbage, le décapage du bois, l'étamage et le traitement des matières plastiques.

**A** 730 °C

**P** Piezo



code							min.	€
CFH 52170	vrac	4001845521701	LM 3000	1,317 kg	-	3	1	<b>38,88</b>
CFH 52156	vrac	4001845521565	LM 1000	0,619 kg	-	8	1	<b>19,25</b>
CFH 52159	vrac	4001845521596	LM 1000	1,660 kg	-	24	1	<b>28,51</b>
CFH 52192	vrac	4001845521923	PZO 7000	0,540 kg	-	3	1	<b>39,74</b>

	CFH 52170	CFH 52156	CFH 52159	CFH 52192
Vermogen (kw) Puissance (kw)	2	2	2	1,66
Autonomie	1 u/h 30	1 u/h 30	1 u/h 30	3 u/h 30
Debiet (g/h) Débit (g/h)	145	145	145	120
	2 x	1 x	5 x	-



**A** 730 °C

**P** Piezo

## PC 140

- Ideaal voor zacht- en hardsolderen. Met stevige, ergonomisch gevormde handgreep en ventiel met hoeveelheidsregeling, voor bediening met één hand. Krachtige speciale brander, geconcentreerde, gebundelde vlam die werktijd verkort en energie bespaart.
- Idéal pour le brasage à haute température et tendre. Équipé d'une poignée stable et ergonomique et d'un régulateur manuel de débit, contrôle d'une seule main. Chalumeau spécial qui produit une flamme concentrée, permet de travailler plus vite et d'économiser de l'énergie.

## LM 1750

- Compact, handig multifunctioneel met krachtige turbobrander. Hardsolderen van koperen buizen tot Ø 22 mm, zachtsolderen tot Ø 28 mm. Ook voor opwarmen, ontdooien, afschroeiën en aansteken van houtskool, thermische kunststofbewerking.
- Compact, pratique et polyvalent, équipé d'un chalumeau turbo performant. Idéal pour le brasage à haute température des tuyaux jusqu'à Ø 22 mm. Aussi pour réchauffage, dégelage, flambage, allumage du charbon de bois, traitement thermique des matières plastiques.

CFH 52130



**A** 700 °C

CFH 52132



**A** 750 °C

**P** Piezo

## TS 1800

- Ideaal voor koperen hardsoldeerverbindingen tot 15 mm en zachtsolderen tot Ø 28 mm. Ook voor opwarmen, ontdooien, afschroeiën en aansteken van houtskool, thermische kunststofbewerking.
- Idéal pour le brasage à haute température sur cuivre jusqu'à Ø 15 mm et pour le brasage tendre jusqu'à Ø 28 mm. Aussi pour réchauffage, dégelage, flambage, allumage du charbon de bois, traitement thermique des matières plastiques.

code							min.	€
CFH 52140		4001845521404	PC 140	0,800 kg	-	3	1	<b>39,20</b>
CFH 52130		4001845521305	LM 1750	0,660 kg	-	2	1	<b>22,97</b>
CFH 52132		4001845521329	TS 1800	0,790 kg	-	2	1	<b>46,81</b>



	CFH 52140	CFH 52130	CFH 52132
<b>Autonomie</b>	1 h 45	4 h	3 h
<b>Energie</b>	 CFH 52109	 AT 2000	 AT 2000



### DIAMANT M70

- Keukenbrander, 360° omkeerbaar. Ideaal voor crème brûlée, karamelliseren, flambieren en gratineren. Met geïntegreerde veiligheidsvoet, navulbaar.
- Chalumeau de cuisine, retournable 360°. Idéal pour la crème brûlée, pour caraméliser, flamber et gratiner. Haute stabilité grâce à un pied de sécurité intégré. A recharger avec du gaz à briquet standard.



**P** Piezo

	CFH 52032	CFH 52402
Vermogen (kw) Puissance (kw)	0,60	0,97
Autonomie	30 min	2 u/h 30
Debiet (g/h) Débit (g/h)	44	70
	1 x	2 x

### HAPPY CAMPER STAR

- Patroonkooktoestel voor een butaangaspatroon van 190 g. Stabiel en zuinig in gebruik.
- Le réchaud à cartouche pour la cartouche de butane 190 g. Stable et de consommation économique.



CFH 52402

code							min.	€
CFH 52032	vrac	4001845520322	DIAMANT M70	0,306 kg	-	1	1	25,12
CFH 52402	vrac	4001845524023	HAPPY CAMPER STAR	1,005 kg	-	8	1	24,75



CFH 52107  
AT 2000  
EN 417

CFH 52515  
AT 3000  
EN 417

CFH 52505

CFH 52103

code							min.	€
<b>Butaan • Butane (DIN EN 417:2012-05)</b>								
CFH 52149	vrac	4001845521497	190 gr	0,270 kg	1152	36	36	2,80
<b>Butaan (70%) + propaan (30%) • Butane (70%) + propane (30%)</b>								
CFH 52109	vrac	4001845521091	230 gr	0,360 kg	-	12	12	7,08
<b>AT 2000 : butaan (70%) + propaan (30%) • butane (70%) + propane (30%)</b>								
CFH 52107	vrac	4001845521077	330 gr	0,450 kg	576	24	24	5,22
<b>AT 3000 : butaan + propaan + propyleen • butane + propane + propylène</b>								
CFH 52515	vrac	4001845525150	330 gr	0,460 kg	-	6	1	8,77
<b>Reservezuurstoffles • Bouteille d'oxygène</b>								
CFH 52505	vrac	4001845525051	1 L	1,320 kg	-	6	1	29,48
<b>Bijvulgas: butaan (86%) + propaan (14%) • Recharge de gaz: butane (86%) + propane (14%)</b>								
CFH 52103	vrac	4001845521039	100 ml	0,090 kg	-	24	24	2,66

### DIN EN 417:2012-05

- **Binnenzijde patroon**  
Toevoeging van een inwendig systeem om gasverlies te beperken.
- **Cartouche vue de l'intérieur**  
Ajout d'un périphérique intérieur pour limiter les fuites de gaz



CFH 52109  
EN 417

CFH 52149  
EN 417

vermogen puissance	2000 W
stand position	1. 60° 2. 650°
luchtstroming débit d'air	500 L / min
kabel • câble	2,00 m



- Ergonomische handgreep
- Poignée ergonomique

**Onkruidbrander E-BIO-Gartner  
Désherbeur E-BIO-Gartner**

- Extra mondstuk om houtskool in barbecue aan te steken
- Embout supplémentaire pour l'allumage du barbecue

code							min.	€
CFH 52662		4001845526621	EBG 662	1,020 kg	-	4	1	<b>30,69</b>

**PZ 7000 DELUXE**

- Eenvoudig in gebruik door gebogen branderbuis met fijnregelventiel. Verwijdert eenvoudig, gifvrij en zonder chemicaliën onkruid en mos in portieken, op buitentrappen, buitenmuren, opritten, voetpaden, terrassen, parkeerplaatsen enz.
- Maniement facile par tube de chalumeau coudé avec valve de réglage fin. Élimine confortablement et efficacement, sans effets nocifs et sans produits chimiques, les mauvaises herbes et la mousse aux entrées de maison, sur les escaliers extérieurs, les façades, aux entrées de propriétés, sur les trottoirs, les terrasses, les parkings, etc.

**Onkruidbrander • Désherbeur**

code							min.	€
CFH 52625		4001845526256	PZ 7000 DELUXE + 1 cartouche	1,200 kg	-	5	1	<b>35,61</b>

97 x 35 x 77 mm    131 x 34 x 77 mm

**DUO onkruidborstel met telescoopsteel  
Brosse DUO de désherbage avec manche télescopique**

code							min.	€
CFH 52670		4001845526706	steel/manche	0,8 - 1,4 m	1,030 kg	-	6	<b>14,13</b>



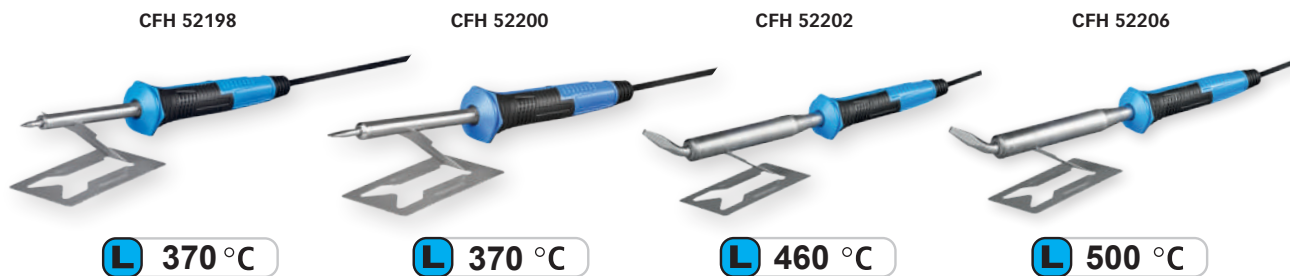

**L** 370 °C

**L** 370 °C

**L** 460 °C

**L** 500 °C

**new design**

Elektrische soldeerbouten - 230 V  
Fers à souder électriques - 230 V



code								min.	€
CFH 52198		4001845521985	15 Watt	E 15	0,237 kg	-	6	1	<b>15,04</b>
CFH 52200		4001845522005	20 Watt	E 20	0,240 kg	-	6	1	<b>15,94</b>
CFH 52202		4001845522029	60 Watt	E 60	0,290 kg	-	6	1	<b>18,86</b>
CFH 52206		4001845522067	100 Watt	E 100	0,300 kg	-	6	1	<b>19,57</b>

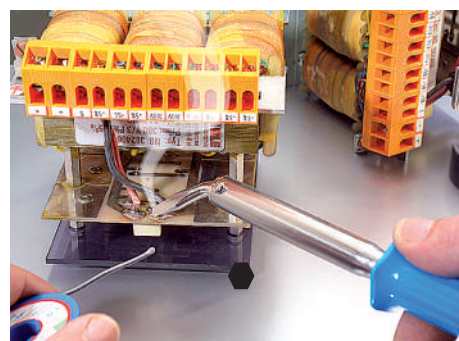
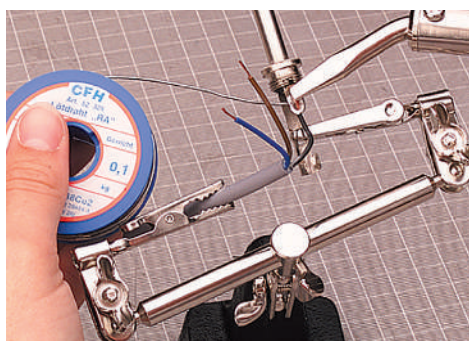

Elektrisch soldeerpistool - 230 V  
Pistolet à braser électrique - 230 V

code								min.	€
CFH 52210		4001845522104	100 Watt	E 100	0,670 kg	-	4	1	<b>22,04</b>

Reservesoldeerpunten op Blz 383 • Pointes de rechanges sur la p. 383

vermogen / puissance opwarming / chauffe	opwarmtijd temps de chauffe	afmetingen / dimensions stift / panne	capaciteit Ø capacité Ø	toepassing application	
15 W CFH 52198	1,5 min	Ø 1 mm	0,7 - 1 mm	<b>L I C H T S O L D E E R W E R K</b>	
20 W CFH 52200	1,5 min	1 x 3 mm	0,7 - 2 mm		Elektronica Electronique
60 W CFH 52202	2 min	1 x 5 mm	1 - 2 mm		Elektronica Radio Electronique
100 W CFH 52206	2,5 min	1 x 5 mm	1 - 2 mm		Radio Elektronica Radio Electronique
100 W CFH 52210	6 - 10 sec	draad / fil	3 mm		Hobby



**Soldeerstation LD 48 • voor hobby en professioneel gebruik  
Station de brassage LD 48 • pour amateurs et professionnels**

code							min.	€
CFH 52216		4001845522166	AC 230V / 50 Hz	2,146 kg	-	1	1	<b>74,00</b>

toegestane belasting tension nominale	AC 230 V / 50 Hz
uitgangsspanning tension de sortie	24 V
vermogen / puissance opwarming / chauffe	max. 48 W
temperatuur température	150° - 420° traploos regelbaar réglable en continu
beschermingsklasse classe de protection	II
toepassing application	electronica electronique modelbouw modélisme

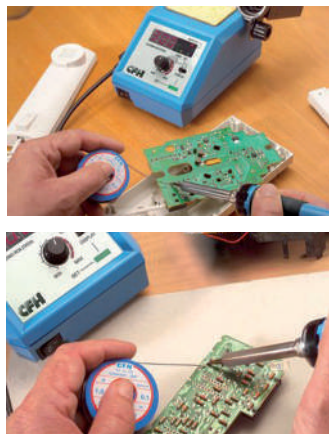
**L 420 °C**
**Reservesoldeerpunten voor elektrische soldeerbouten  
Pointes de rechange pour fers à souder électriques**

code							min.	€
			voor / pour					
CFH 52126	vrac	4001845521268	CFH 52200 (20W)	0,013 kg	-	2	2	<b>2,94</b>
CFH 52127	vrac	4001845521275	CFH 52202/52206 (60/100W)	0,039 kg	-	2	2	<b>3,58</b>
CFH 52128	vrac	4001845521282	CFH 52210 (100W)	0,067 kg	-	2	2	<b>3,08</b>
CFH 52129	vrac	4001845521299	CFH 52198 (15W)	0,007 kg	-	2	2	<b>3,08</b>



**Gassoldeertoestel DIAMANT M40 • Braseur à gaz DIAMANT M40**

code							min.	€
CFH 52025		4001845520254	M40	1,128 kg	-	4	1	<b>34,71</b>

**Gassoldeertoestel in set • Braseur à gaz en set**

code							min.	€
CFH 52028		4001845520285	M28	0,342 kg	-	1	1	<b>38,99</b>

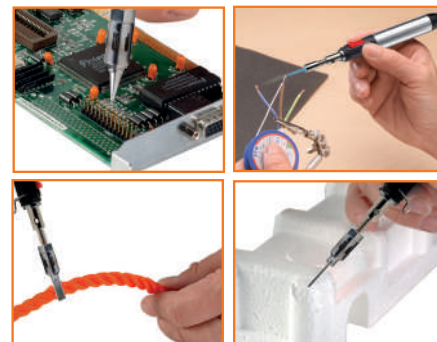
- Voor het smelten van glas en de meest uiteenlopende metalen (tin, koper, aluminium, zilver, goud enz.).
- Pour la fusion du verre et de divers métaux (étain, cuivre, aluminium, argent, or, etc.).

**Desoldeerpomp • Pompe à dessouder**

code							min.	€
CFH 52237	vrac	4001845522371	EP 237	0,061 kg	-	1	1	<b>4,71</b>

- Voor soldeerwerk in de elektronica, modelbouw enz. Voor het verwijderen van soldeerpunten vóór het vervangen van elektronische componenten enz.
- Pour travaux de brasage dans le secteur électronique, le modélisme, etc.  
Pour enlever les points de brasage avant le remplacement des composants électroniques.



CARACTÉRISTIQUES

KENMERKEN

	ESG 140 CFH 52845	<b>NEW</b> ISG 147 CFH 52881
50/60 Hz V	230V	230V
A	16 A	14,5 A
<b>Kw</b> 100%	2,30 Kw	3,33 Kw
<b>A</b>	40 - 140 A	10 - 120 A
mm	1,5 - 3,2 mm	1,5 - 3,2 mm
<b>IP</b>	IP 21	IP 22
cm	29,5 x 23,5 x 36,5	38,3 x 23,5 x 24
	13,8 kg	3,5 kg



CE

**ESG 140**  
MMA  
BOOGLASSEN  
SOUDURE À L'ARC



**NEW**

**ISG 147**  
MMA / WIG  
INVERTER



code							min.	€
CFH 52845	vrac	4001845528458	MMA	13,950 kg	-	1	1	<b>237,00</b>
CFH 52881	vrac	4001845528816	MMA / WIG	3,500 kg	-	1	1	<b>385,00</b>



**Toebehoren voor lasapparaten • Accessoires pour postes à souder**

code			Max A					min.	€
<b>Elektrodenhouder • Porte-électrode</b>									
CFH 52550		4001845525501	200 A	Max 2,4mm	0,315 kg	-	1	1	<b>11,96</b>
<b>Massaklem • Borne de mise à la masse</b>				voor / pour					
CFH 52554		4001845525549	150 A	M6	0,200 kg	-	1	1	<b>5,75</b>
<b>Hoekmagneten • Aimants d'angle</b>									
CFH 52700		4001845527000	82 x 120 x 14 mm	WM 700	0,333 kg	-	3	1	<b>4,87</b>
CFH 52702		4001845527024	102 x 155 x 16 mm	WM 702	0,633 kg	-	3	1	<b>7,15</b>

Hardsolderen Brasure fort	Ø mm	samenstelling composition	fusiebereik intervalle de fusion	toepassing application
	2	CP203 (L - CuP6)	730°C	koper en koperlegeringen cuivre et alliages cuivraux
	2	Cu303 (L - CuZn 40) messing ommanteld laiton enrobé	900°C	sleuf en voegen in staal fente et joint en acier
	Δ10	Sn 91 Zn 9	200°C	plaatzink / tôle de zinc

code								min.	€
------	--	--	--	--	--	--	--	------	---

**94% Koper / 6% Fosfor • 94% Cuivre / 6% Phosphore**

CFH 52310		4001845523101	333 mm	5 st / pcs	0,070 kg	-	1	1	<b>5,04</b>
-----------	--	---------------	--------	------------	----------	---	---	---	-------------

**Messing omhuld 60% Koper / 40% Messing • Laiton enrobé 60% Cuivre / 40% Laiton**

CFH 52305		4001845523057	333 mm	5 st / pcs	0,071 kg	-	1	1	<b>4,95</b>
-----------	--	---------------	--------	------------	----------	---	---	---	-------------

**91% Tin / 9% Zink • 91% Étain / 9% Zinc**

CFH 52369		4001845523699	400 mm	4 st / pcs	1,500 kg	-	1	1	<b>81,90</b>
-----------	--	---------------	--------	------------	----------	---	---	---	--------------

**Loodvrij!  
Sans plomb!**
**Soldeerdraad met harskern • Fil de soudure, âme décapante**

Tinsolderen Soudure étain	Ø mm	samenstelling composition	smelttraject intervalle de fusion	toepassing application
CFH 52319	1,0	Sn100Ni+	227°C	elektronica / électronique
CFH 52324	1,0	Sn100Ni+	227°C	elektronica / électronique
CFH 52329	2,0	Sn99,3Cu0,7	227°C	hobby
CFH 52340	3,0	Sn97Cu3	310°C	fitting

code				Inhoud Contenu				min.	€
------	--	--	--	-------------------	--	--	--	------	---

● CFH 52319		4001845523194	electronica	70 gr	0,100 kg	-	10	1	<b>14,37</b>
● CFH 52324		4001845523248	electronica	70 gr	0,100 kg	-	10	1	<b>10,95</b>
● CFH 52329		4001845523293	hobby	70 gr	0,100 kg	-	10	1	<b>8,45</b>
● CFH 52340		4001845523408	fitting	100 gr	0,130 kg	-	10	1	<b>11,16</b>

**NEW**
**synthetische hars  
résine synthétique**

**ECO TIN**  
FAIR RESOURCING

**CFH 52319**
**Loodvrij!  
Sans plomb!**
**CFH 52324**
**NEW**

**CFH 52329**
**CFH 52340**
**NEW**

**Soldeervloeistof • Liquide à souder**

code				Inhoud Contenu				min.	€
CFH 52368		4001845523682	koper / cuivre	100 gr	0,136 kg	-	2	1	<b>7,65</b>
CFH 52372		4001845523729	zink / zinc	100 gr	0,130 kg	-	2	1	<b>6,82</b>

**Universele staafelektroden • Electrodes en baguette**
**EN 29454.1.3.2.2.A**

code				Inhoud Contenu				min.	€
CFH 52352		4001845523521	2,0 x 300	10 st / pcs	0,100 kg	-	1	1	<b>2,78</b>
CFH 52392		4001845523927	2,0 x 300	2,0 kg	2,068 kg	-	1	1	<b>23,92</b>
CFH 52354		4001845523545	2,5 x 350	8 st / pcs	0,150 kg	-	1	1	<b>2,97</b>
CFH 52394		4001845523941	2,5 x 350	2,5 kg	2,564 kg	-	1	1	<b>23,15</b>
CFH 52356		4001845523569	3,2 x 350	5 st / pcs	0,166 kg	-	1	1	<b>2,97</b>
CFH 52396		4001845523965	3,2 x 350	2,5 kg	2,573 kg	-	1	1	<b>22,95</b>

**Autogeenlasstaaf, verkoperd • Baguette cuivrée pour souder à l'autogène**

code				Inhoud Contenu				min.	€
CFH 52360		4001845523606	mm	1,5 x 333	15 st/pcs	0,090 kg	-	1	<b>2,89</b>

**Teflon tape in dispenser • Ruban téflon en dispenser**

code							min.	€
CFH 51792		4001845517926	12 m	0,023 kg	-	1	1	<b>4,10</b>





#### Aanstekers • Allume-feu

code									min.	€
				cm						
CFH 52446	display	4001845524467	flexibel / flexible	33,5	0,090 kg	-	30	1		<b>4,61</b>
CFH 52442	display	4001845524429	MAXI	28	0,061 kg	-	30	1		<b>3,94</b>
CFH 52436	display	4001845524368	MINI	13,5	0,025 kg	-	54	1		<b>3,31</b>
CFH 52448	display	4001845524481	flexibel / flexible	34,5	0,088 kg	90	30	1		<b>5,01</b>
CFH 52486	display	4001845524863	Fancy GF 486	-	0,055 kg	96	32	1		<b>5,09</b>
<b>prijs per 3 st • prix par 3 pcs</b>										
CFH 52484	display	4001845524849	3 st/pcs	-	0,055 kg	-	50	1		<b>2,55</b>

